

# SMD Power Inductor CDRH104R/T125

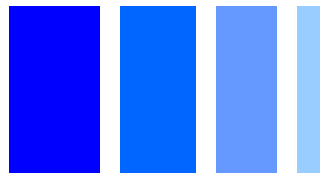

## Description

- Ferrite drum core construction.
- Magnetically shielded.
- L × W × H: 10.5 × 10.3 × 4.0 mm Max.
- Product weight: 1.5g(Ref.)
- Moisture Sensitivity Level: 1
- RoHS compliance.
- Qualified to AEC-Q200.

## Dimension - [mm]

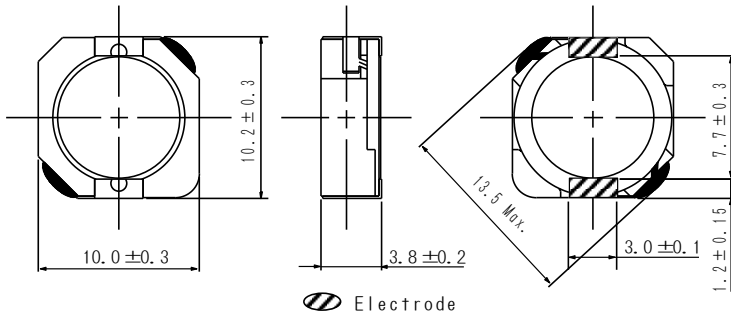

## Environmental Data

- Operating temperature range: -40°C ~ +125°C (including coil's self temperature rise)
- Storage temperature range: -40°C ~ +125°C
- Solder reflow temperature: 260 °C peak.

## Packaging

- Carrier tape and reel packaging
- 13" diameter reel
- 1000pcs per reel

## Applications

- Automotive.

## Land pattern and Schematics - [mm]

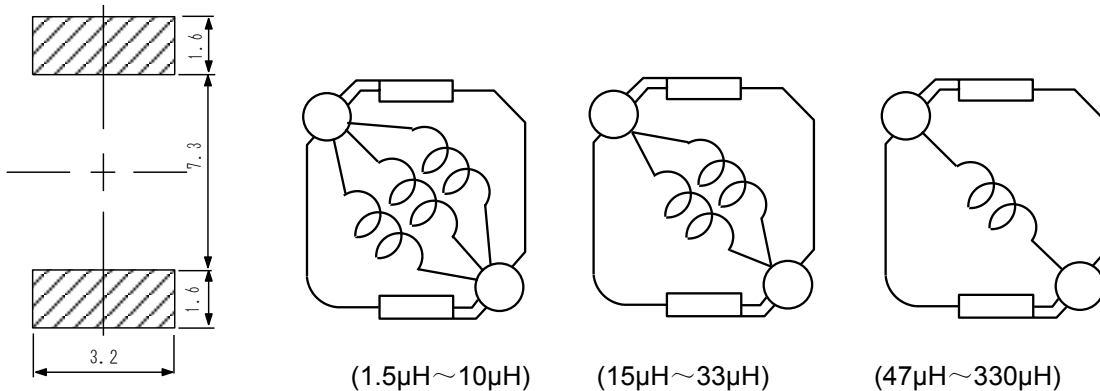

# SMD Power Inductor

## CDRH104R/T125



### Electrical Characteristics

Part No.	Stamp	Inductance ( $\mu\text{H}$ ) [Within] ※1	D.C.R. ( $\Omega$ ) [Max.] (at 20°C) ※2	Rated current (A)		
				Saturation current (A) ※3		Temperature rise current (A) ※4
				(at 20°C)	(at 125°C) (Typ.)	
CDRH104RT125NP-1R4PC	1R4	1.4 $\pm$ 25%	9.0m(7.2m)	9.20	7.36	7.80
CDRH104RT125NP-2R2PC	2R2	2.2 $\pm$ 25%	11.0m(8.8m)	8.00	6.16	7.10
CDRH104RT125NP-3R6PC	3R6	3.6 $\pm$ 25%	14.0m(11.2m)	6.07	5.00	6.20
CDRH104RT125NP-4R7PC	4R7	4.7 $\pm$ 25%	19.1m(15.3m)	5.57	4.60	5.20
CDRH104RT125NP-6R8PC	6R8	6.8 $\pm$ 25%	25.6m(20.5m)	4.66	3.94	4.40
CDRH104RT125NP-100MC	100	10 $\pm$ 20%	36.8m(29.5m)	4.10	3.46	3.50
CDRH104RT125NP-150MC	150	15 $\pm$ 20%	48.1m(38.5m)	3.34	2.80	2.90
CDRH104RT125NP-220MC	220	22 $\pm$ 20%	70.0m(56.0m)	2.56	2.18	2.30
CDRH104RT125NP-330MC	330	33 $\pm$ 20%	93.8m(75.0m)	2.14	1.80	2.05
CDRH104RT125NP-470MC	470	47 $\pm$ 20%	136m(109m)	1.80	1.51	1.68
CDRH104RT125NP-680MC	680	68 $\pm$ 20%	216m(173m)	1.57	1.32	1.25
CDRH104RT125NP-101MC	101	100 $\pm$ 20%	300m(240m)	1.30	1.10	1.05
CDRH104RT125NP-151MC	151	150 $\pm$ 20%	448m(358m)	1.00	0.85	0.86
CDRH104RT125NP-221MC	221	220 $\pm$ 20%	694m(555m)	0.85	0.72	0.68
CDRH104RT125NP-331MC	331	330 $\pm$ 20%	1.06(850m)	0.70	0.58	0.56

※ 1 Measuring condition: at 100kHz.

※ 2 ( ) are typical value.

※ 3 Saturation current: The value of D.C. current when the inductance decreases to 65% of it's nominal value.

※ 4 Temperature rise current: The value of D.C. current when the temperature rise is  $\Delta t=40^\circ\text{C}$  ( $T_a=20^\circ\text{C}$ ).

# SMD Power Inductor CDRH104R/T125



## Saturation Current & Temperature Rise Graph

— L (20°C) — L (125°C) —  $\Delta T$

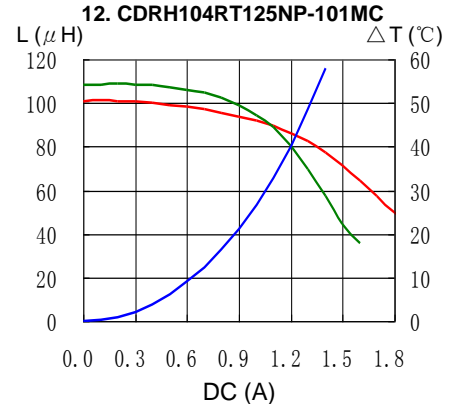
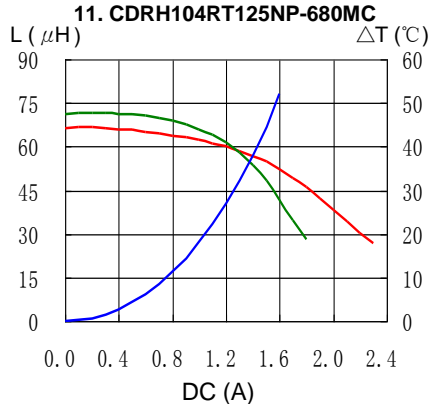
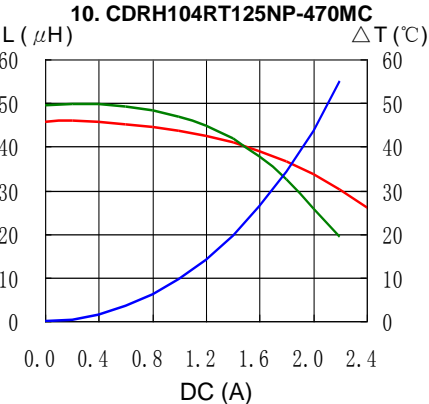
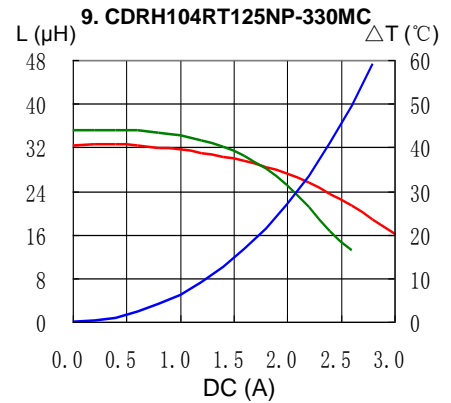
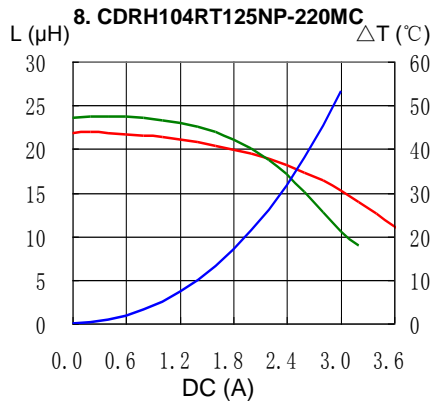
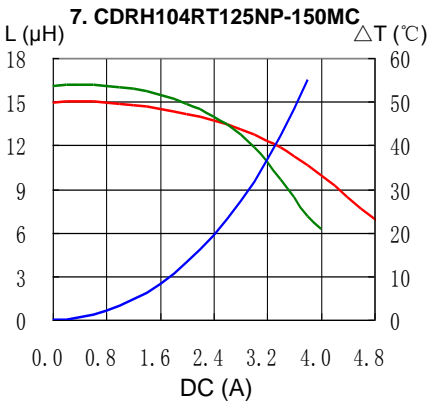
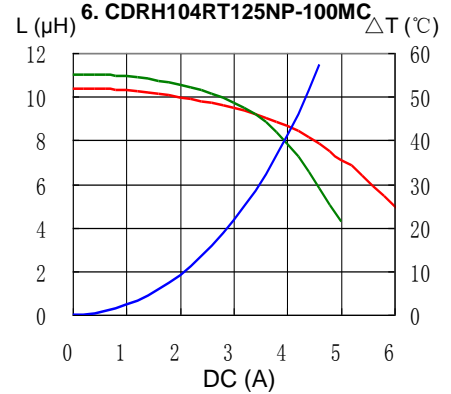
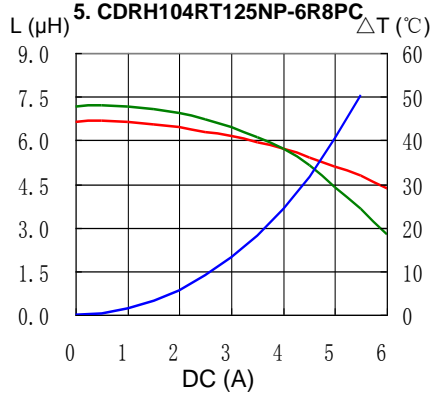
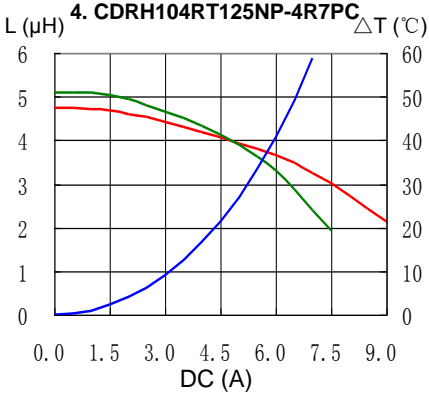
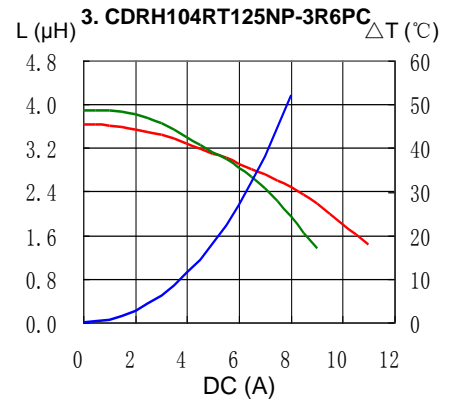
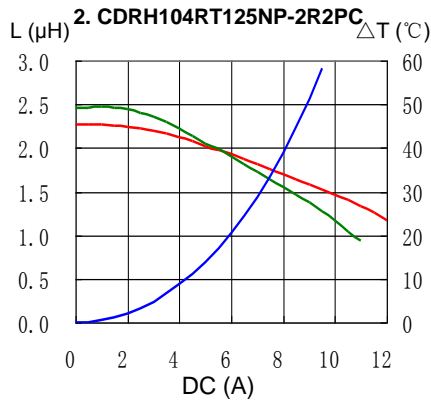
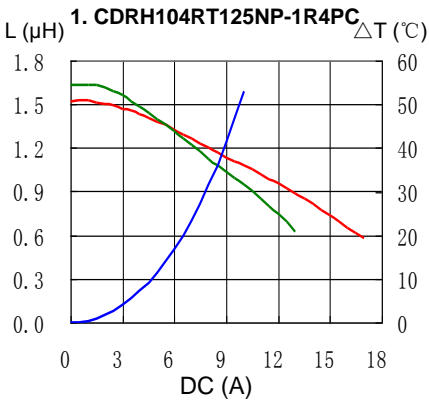

# SMD Power Inductor CDRH104R/T125

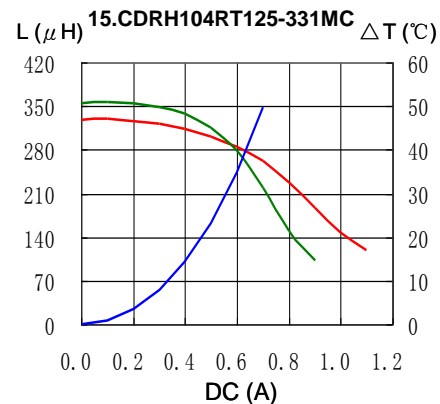
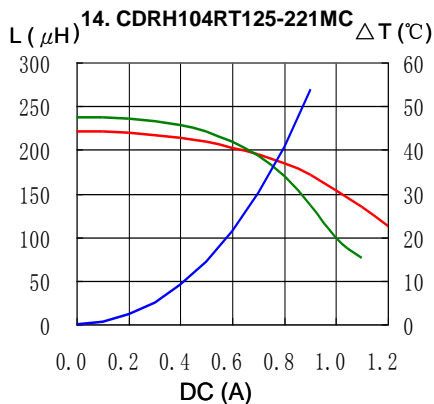
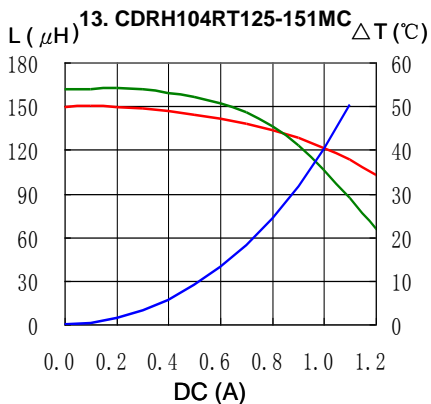

## Solder Reflow Condition

**Heat Endurance**

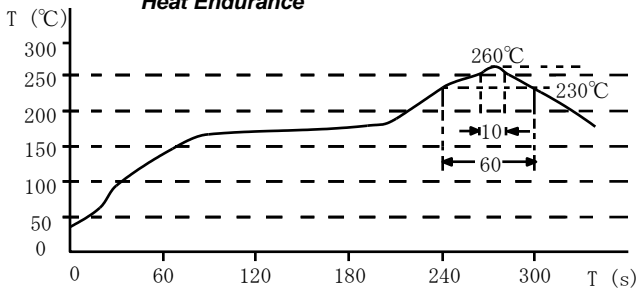

**Temperature Chart**

