

LF Receiver Antenna CAD10D30

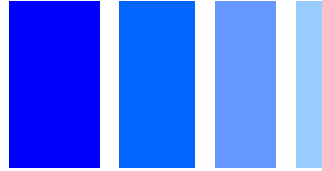

Description

- LF receiver antenna for Z axis.
- Low profile.
- L × W × H: 9.6 × 9.2x 3.2 mm Max.
- Product weight:0.61g Ref..
- RoHS compliance.

Environmental Data

- Operating temperature range: -40°C~+85°C
- Storage temperature range: -40°C~+125°C

Packaging

- Carrier Tape and Reel.
- Tape specification according to EIA481.
- 1000pcs/reel.

Applications

- PEPS, Smart key system.
- Security system



Dimension - [mm]

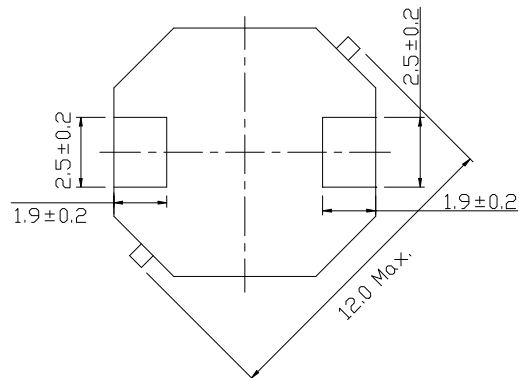
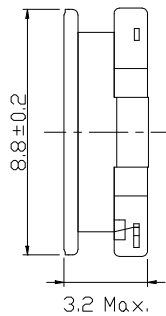
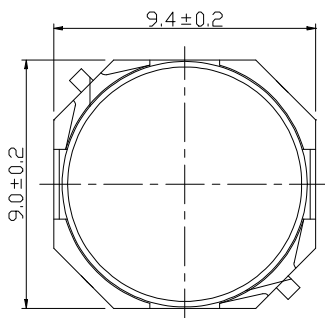

Suggest PCB layout - [mm]

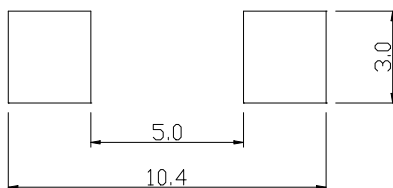

Schematic diagram

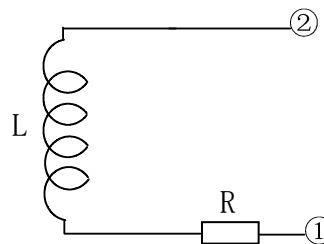

L: Ferrite core coil inductance.
R: Copper resistance.

LF Receiver Antenna CAD10D30

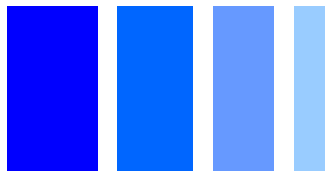

Electrical Characteristics

Part No.	Stamp	Inductance(1-2)		Unloaded Q Min.	SRF Min.(kHz)	DCR Ref.(Ω)
		(mH)	Within(%)			
CAD10D30-223	223	2.38	± 5	50	1000	21
CAD10D30-242	242	2.47	± 5	50	1000	26
CAD10D30-342	342	3.45	± 5	50	1000	27
CAD10D30-402	402	4.05	± 5	50	1000	33
CAD10D30-472	472	4.77	± 5	50	1000	38
CAD10D30-492	492	4.90	± 5	50	1000	39
CAD10D30-722	722	7.20	± 5	50	700	59
CAD10D30-902	902	9.0	± 5	50	700	75
CAD10D30-103	103	10.0	± 5	50	700	81
CAD10D30-163	163	16.2	± 5	50	500	127

* It is possible for different inductance value.